



Meyer Portable Vacuums

OPERATION & MAINTENANCE INSTRUCTIONS



Read this manual carefully before operating or maintaining this equipment. Use vacuums for the intended purpose/material only. Failure to do so could result in serious injury or death.

Save this manual

FOR MODELS:

VERSA-VAC™ (Insulation Removal)

VELOCI-VAC® (Insulation Removal & Air Duct Cleaning)

PORTA-VAC® (Air Duct Cleaning)

Wm. W. Meyer & Sons, Inc.

1700 Franklin Blvd. • Libertyville, Illinois 60048-4407 • 800-963-4458 • 847-918-0111 • Fax: 847-918-8183
sales@wmwmeyer.com • meyercontractor.com or wmwmeyer.com

TABLE OF CONTENTS

Safety Precautions	2
Applications - Intended Use of Equipment.....	6
Receiving and Uncrating	6
Start-Up & Operation.....	7
Shut Down.....	10
Maintenance	10



SECTION I SAFETY PRECAUTIONS

TO THE OWNER, OPERATION AND MAINTENANCE PERSONNEL

The safety of the operator and those people that may come into contact with the equipment is of great importance to Wm. W. Meyer & Sons, Inc. (“Meyer” “factory”). The decals, shields, guards, and other protective features designed, furnished, or recommended for this machine are there for your protection. BEFORE attempting to operate or perform maintenance on this equipment READ carefully and UNDERSTAND all safety instructions contained in this set of **Instructions**. Failure to do so could result in serious injury or death.

Equipment owner responsibilities

Equipment owners are responsible for understanding the contents of this document and compliance with applicable government laws and regulations and appropriate industry standards including the proper disposal of all collected material. The owner should also contact any associations affiliated with their market for any training, certification, and/or proper procedures (suggested or required), for their particular business. Appropriate safety and equipment training is the responsibility of the owner. The owner/operator is responsible for any hazards related to the material that is being handled by the vacuums and for ensuring that the users of the equipment have and use the proper Personnel Protective Equipment (PPE). In addition, the owner must create a Lockout/ Tagout procedure for personnel to follow before performing any maintenance on this equipment. This manual is intended to assist the owner in the training process. The operation and maintenance of this equipment should be restricted to those trained in its use and possess the expert knowledge to perform maintenance.

Operation and Maintenance personnel responsibilities

Personnel that are operating or maintaining this equipment must READ carefully and UNDERSTAND the sections of this **Instruction Manual** relevant to the work they are performing. The various precautions and recommendations detailed within this manual are not necessarily all-inclusive. These instructions are intended to provide general safety and operational guidance relating to typical uses with which Meyer is familiar. If you have any safety or operational questions pertaining to the design or application of the equipment, we encourage you to contact Meyer at (800) 963-445

SIGNAL WORD DEFINITIONS

 **DANGER** Indicates the presence of a hazardous situation that, if not avoided, WILL result in death or serious injury.

 **WARNING** Indicates the presence of a hazardous situation that, if not avoided, COULD result in death or serious injury.

 **CAUTION** Indicates the presence of a hazardous situation that, if not avoided, COULD result in minor or moderate injury.

 **NOTICE** Indicates information that is important, but is not related to a particular hazard.

IMPORTANT SAFETY INFORMATION

 **WARNING** To reduce the risk of serious injury or death:

Be qualified.

- Operation of this equipment must be limited to those that are properly trained in its use.
- Servicing or maintaining this equipment must be performed by trained maintenance personnel only.

Read all safety information.

- Read and understand all the **safety-related information contained in this manual** and the **Engine manual** prior to attempting to perform any work on this equipment.
- Obey all the **safety labels** on the equipment. Do not remove any safety labels. If the equipment is missing any labels (see “Safety Labeling” section); contact the factory immediately, before putting the equipment into service.

Heavy – handle safely. The weight of this equipment and its component parts could cause serious injury if dropped or mishandled during service or maintenance. Always use safe handling and rigging methods.

Guard and avoid dangerous internal parts. The internals of this equipment contains a moving part that will crush and cut any body part it contacts, resulting in serious injury or death.

- **Inlet and outlet openings** must always be properly guarded by being connected to some type of ducting (hose) on the inlet and a collection device or ducting on the outlet. Do not operate with the inlet or outlet exposed.
- **Switches and Guards** must be installed in the proper location and be in working order before operating equipment.
- **Never reach inside** the equipment for any reason while it is in operation.

Do not disable any switches they are there for your protection.

Never leave the equipment unattended while it is running.

Keep clear. Always keep hands, feet, or other body parts, loose clothing, jewelry, away from the inlet, outlet, and collection bag.

Lockout/Tagout engine before servicing or maintaining this equipment.

- Remove and maintain exclusive control of the engine ignition key.
- Before working on engine or equipment, disable engine as follows: Disconnect spark plug lead(s). Disconnect negative (–) battery cable from battery.
- Engine and exhaust surfaces may be hot; allow them to cool before performing any work.
- Follow your employer’s Lockout/Tagout procedures.

If a malfunction should occur, turn the machine off immediately and correct the problem, before restarting the machine. If there are any questions as to the safe operation of this equipment, please do not hesitate to contact us at 1-800-963-4458.

HAZARD IDENTIFICATION

Principle of operation

The portable vacuums that Meyer & Sons manufactures are based on a centrifugal fan design that utilizes a high-speed material handling style wheel enclosed in a scroll-shaped housing. The air is drawn in towards the center of the wheel and thrown outward as the wheel rotates. The shape of the housing directs the air out perpendicular to the inlet. Because of the design, the wheel is accessible via either the inlet or outlet. The Versa-Vac™ and Veloci-Vac® have interlock switches, consisting of an inlet switch and an outlet switch that are electrically connected to the engine. These switches must be depressed in order for the engine to start and continue running. The Porta-Vac® design incorporates permanent inlet and outlet grates.

Amputation hazard

The centrifugal fan wheel of the vacuum is driven by an engine at a relatively high rpm. If either the inlet or outlet openings are left unguarded, the fan wheel presents a serious personal injury hazard, including but not limited to amputation. Any part of the human body in the way of the fan wheel **will** be cut off.

Guarding inlet

In order for the vacuum to function, the inlet must be connected to a hose or other ducting through which the vacuum (negative pressure airflow) is drawn. The inlet is guarded by virtue of being connected to ducting of sufficient length to not allow a body part to come in contact with the fan wheel. There is an inlet switch (models Versa-Vac™ & Veloci-Vac®) that is electrically connected to the vacuum engine that must be engaged in order for the engine to start and continue to run. The switch is engaged by placing ducting over the switch lever and inlet opening prior to start up. Disengaging the switch does not immediately stop the fan wheel rotation; it will take a few seconds before it comes to a complete stop. DO NOT defeat this switch. Circumventing this switch will render the vacuum unsafe to use. It is the responsibility of the equipment owner/operator to ensure that the inlet is not exposed and that the inlet switch is in good working order and the vacuum is safe to operate.

Guarding outlet



The outlet of vacuum is, by design, open and can expose a person to the interior of the vacuum and thus the fan wheel. This opening, like the inlet, (model Versa-Vac™) has a switch that must be engaged in order for the vacuum engine to start and continue to run. A hose or collection device/debris guard must be attached to the outlet so that no one can access the interior of the vacuum. DO NOT defeat the outlet switch or circumvent its utility in any way. Doing so will render the vacuum unsafe to use. The Veloci-Vac® has a self-closing grate that must be lifted up to access the outlet. It is the responsibility of the equipment owner/operator to ensure that the outlet is not exposed and that the outlet switch is in good working order and the vacuum is safe to operate.

Training



The owner also bears the responsibility to ensure that personnel who may be working around or operating the vacuum are properly trained. Personnel **must** be aware that: (1) anything coming into contact with the moving fan wheel **will** be cut off/amputated; (2) before working on, cleaning, repairing or maintaining a vacuum, Lockout/Tagout procedures **must** be strictly followed; and (3) the vacuum **must not** be operated without guarding in place. Before working around a vacuum, personnel must read the Operator's Manual.

SAFETY LABELING



The following safety labels shown are affixed on the equipment. (NOTE: Labels 420Z-263 and 420Z-265 are **ONLY** affixed on the Versa-Vac™ units.) A Safety Supplement Datasheet has been packed with your equipment at the time of shipment. **Do Not** use the machine if any labels are missing, damaged, or have fallen off.

	 WARNING	 <p>Scan code for instruction manual</p> <p><small>420Z-235</small></p>
	<p>To reduce the risk of serious injury or death:</p> <p>Equipment must be operated, serviced and maintained by trained personnel.</p> <p>Read and understand all instructions before operating, maintaining or servicing this machine.</p>	

	 WARNING
	<p>Hot surface. Do NOT touch.</p> <p><small>420Z-233</small></p>

	 DANGER
	<p>Turn OFF & remove key from ignition before servicing or maintaining equipment.</p> <p>Rotating fan blades inside can crush or cut.</p> <p>Read and understand all instructions before operating, maintaining or servicing this machine.</p> <p><small>420Z-208</small></p>

	 DANGER
	<p>Engines produce carbon monoxide which is an odorless deadly poison. DO NOT OPERATE in an enclosed area.</p> <p><small>420Z-234</small></p>

 	 WARNING
	<p>Stay clear of outlet and surrounding area when operating.</p> <p>Pressurized gas and material leaving outlet can cause severe injury or death if personnel are struck.</p> <p>Rotating fan blades inside can crush or cut.</p> <p>Never operate without collection device securely connected to outlet.</p> <p><small>420Z-209</small></p>

 WARNING
<p>Attach debris guard or hose before starting vacuum.</p> <p>Failure to do so could result in serious injury or death</p> <p>Flying objects leaving discharge.</p> <p><small>420Z-265</small></p>

	 WARNING
	<p>Stay clear of inlet when operating.</p> <p>Strong suction – clothing, hair, body parts, and other objects may be pulled into inlet.</p> <p>Rotating fan blades inside can crush or cut.</p> <p>Avoid wearing loose clothing or jewelry when operating.</p> <p><small>420Z-210</small></p>

 WARNING
<p>Flying objects leaving discharge.</p> <p>Debris guard or hose must be attached to discharge before operating vacuum.</p> <p>Failure to do so could result in serious injury or death.</p> <p><small>420Z-263</small></p>

 WARNING					
 Hearing protection required	 Eye protection required	 Breathing protection required	 Protective clothing required		<small>420Z-204</small>

 WARNING
<p>This side must face up.</p> <p>Failure to install the debris guard properly could result in serious injury or death.</p> <p>Flying objects leaving discharge.</p> <p><small>420Z-267</small></p>

Replacement label kits are available at no charge from Wm. W. Meyer & Sons, Inc. 1-800-963-4458. Keep this supplement with the machine for quick reference.

INFORMATION FOR SAFETY AND SERVICE

A record of every Meyer Portable Vacuum is kept on file at the factory for a substantial period of time. If you have any safety or equipment related questions, we encourage you to contact the Meyer factory based on the cover contact information.

The serial number is located on a metal identification label permanently affixed to every vacuum before it leaves the factory. To aid us in providing you with service, application assistance, and help with spare parts requirements, please record the following:

Model _____

Serial Number _____



SECTION II APPLICATION – INTENDED USE OF EQUIPMENT

The Meyer line of vacuums is designed to safely and easily remove only the intended materials.

Vacuum Model	Insulation Removal	Air Duct Cleaning
Versa-Vac™	X	
Veloci-Vac®	X	X
Porta-Vac®		X



WARNING

This equipment must be used only for the purpose for which it was intended. Any other use could result in serious injury, costly damage to the equipment and void the warranty.



SECTION III RECEIVING AND UNCRATING

A. RECEIVING AND INSPECTION

Upon receipt of equipment and material from Meyer, the following basic steps should be taken. The equipment is heavy and proper handling procedures should be used (See the “**Heavy - handle safely**” information in the “IMPORTANT SAFETY INFORMATION” section).

1. Use the packing list to determine that all the items shipped have been received. Your equipment was carefully crated for safe shipment when given to the carrier. If items are missing, contact Meyer, per the contact information at the end of this section.
2. Check for damage. Damage in transit is the responsibility of the carrier. Title to your equipment and all other items in the shipment were transferred to you as soon as the shipment left our dock, thus it is your responsibility to handle any claim. In the event damage has occurred:
 - a. Be sure to have the driver sign a copy of the freight bill with a notation about any damage and contact their office before the driver leaves your premises.

- b. Contact the carrier to arrange for an independent inspector to come out to inspect the damage and to prepare the inspection report. It is imperative that this inspection is done before you start to unpack or use any of the equipment.
- c. If there are any visible problems with your unit or any other items in the shipment, you or the driver must note in detail the damage on all copies of the freight bill before signing for the shipment. Then immediately call Meyer.
- d. Photographic records of the damage are helpful to communicate the extent and type of damage as well as to provide a clear record.
- e. In addition to inspecting damaged equipment, you should also check the condition of the safety labels to ensure they have not been damaged or come off. If they have, contact the factory for replacements prior to installation.
- f. Concealed Damage: If equipment or goods are discovered to be damaged in shipment at a later date, contact the carrier and Meyer immediately.
- g. In all cases of damage in transit, contact Meyer for assistance in determining whether or not this damage may, in any way, affect safety or proper operation. Please contact us so that we can assist you with replacement parts or with any questions about the claim process using the following contact information.

Wm. W. Meyer & Sons, Inc.
1700 Franklin Blvd.
Libertyville, IL60048

800-963-4458 or 847-918-0111
sales@wmwmeyer.com

Uncrate and carefully remove all of the packing materials and check the parts against the Packing List. Your vacuum was test-run and shipped with all the fluids at the proper levels. Check them now and top off as necessary.



SECTION IV START-UP & OPERATION

Read and understand the information in the “IMPORTANT SAFETY INFORMATION” section before operating the equipment. In addition, familiarize yourself with the following statements.

⚠ DANGER Failure to follow these precautions will lead to serious injury or death.

Carbon monoxide

- The exhaust from the vacuum engine contains carbon monoxide, a deadly, odorless poison.
- The vacuums should never be used inside buildings or garages, even if doors and windows are open.
- They should be used outdoors only, far from windows, doors, and vents.

Verify inlet and outlet are guarded and stay clear

There must be a hose connected to the inlet and either a hose or discharge bag connected to the outlet. Do not stand near the inlet, inlet hose, outlet, discharge hose, or discharge collection bag while the unit is starting, running or shutting down.

- The rotating fan blades will crush or cut if they come in contact with any body parts. Follow Lockout/Tagout procedures before attempting to access the inside of the vacuum.
- Stay clear of the inlet of the vacuum. A strong suction is present at the inlet and can pull in clothing, hair, body parts, and other objects. Avoid wearing loose clothing or jewelry when operating.
- Never reach inside the vacuum inlet or outlet while the unit is running.
- Stay clear of the outlet of the vacuum to avoid being struck by fast-moving material discharging from the vacuum.

 **WARNING** Failure to follow these precautions can lead to serious injury or death.

Fuel safety

To reduce the risk of fire:

- To prevent static electrical discharge igniting fuel vapors, the fuel tank must be in contact with the ground before and during filling.
- Do not overfill the fuel tank. Leave room for the expansion of the fuel.
- Fill the tank away from the engine and avoid spills.
- If the fuel tank is attached to the engine, allow the engine to cool before filling.

Hot surfaces

To reduce the risk of fire or being burned, follow these instructions:

- Do not touch hot engine or exhaust surfaces. Allow them to cool.
- Do not allow anything to come in contact with hot engine or exhaust surfaces such as bags or hoses.

Do not vacuum up or operate near the following:

- Hazardous or toxic material
- Flammable materials, materials that are self-heating or can burn
- Hot, burning or smoldering material

Determine what will be removed

Vacuumed materials may get into the air or be contacted once collected.

- Inspect the material which will be removed.
 - Ensure that it is material that is compatible with the vacuum being used.
 - Remove any objects that could damage the vacuum or injure someone when the material is discharged.
- Take appropriate precautions for the potential health hazards of the material to be removed.
 - Potential health hazards could include but are not limited to: Skin irritation, eye irritation, and respiratory ailments.
 - Use the proper Personal Protective Equipment (PPE) such as long sleeve shirt and pants, safety glasses or goggles, appropriate respirators, and hearing protection.

It is the operator's responsibility to ensure that only the intended materials: fiberglass, cellulose (properly treated with fire retardant), and rock wool insulation are collected in the removal process. In the case of air duct cleaning, only common household dust shall be removed.

Equipment Set-Up

1. Place your equipment on a level surface and out of the wind, if possible. If your model comes with a wheel locking device, engage it.
2. Attach debris guard, discharge "Y", or hose to the outlet.

⚠ WARNING Debris guard, discharge “Y”, or hose must be attached to the outlet before operating the vacuum to reduce the risk of serious injury or death from flying objects leaving the discharge.

Note: The Versa-Vac™ requires that either a hose or the debris guard is attached to the outlet (refer to figure A). The vacuum will not start or continue to run without a hose or the debris guard attached.

The Veloci-Vac® has a discharge “Y” (refer to figure B) that must be mounted before any attachment. The “Y” locks into place with a clockwise twist.



Figure A



Figure B

3. Attach a collection bag over the debris guard or “Y”.

⚠ WARNING Fire hazard – Position the collection bag so that it will not be blown by the wind and come in contact with the engine exhaust system. If necessary, weight it down until enough material has been collected to make the bag heavier and stay in place.

4. Attach the hose to the inlet of the vacuum using the clamp provided. Additional hose lengths may be added to the inlet hose using hose connectors and clamps. The vacuum will function better with less hose.
5. Connect the fuel tank to the engine using the quick connect coupling and open the vent on the tank. The vacuum is now ready to be operated.

Equipment starting

1. Before starting the engine, refer to the engine manual for the correct start-up and shutdown procedures. Never run the vacuum engine faster than factory settings.
2. Start the engine and let it warm up before vacuuming.
3. Always have at least one operator at the vacuum at all times. Do Not leave the vacuum unattended while running.

⚠ WARNING If noise or vibration is coming from the fan, stop the vacuum immediately! This indicates that the fan wheel has gone out of balance and may explode. Failure to shut down the vacuum immediately could result in serious injury or death or costly damage to the equipment. Do not operate until it has been thoroughly checked by the factory or factory authorized representative.



**SECTION V
SHUT DOWN**

 **DANGER** Rotating fan wheel inside can crush and cut. Do not remove any inlet or discharge attachment until the vacuum has come to a complete stop. Do not stand near the inlet, inlet hose, discharge hose, or discharge collection bag while the unit is shutting down. Failure to do so will expose the operator to a moving fan wheel which if contacted, will lead to serious injury or death.

1. Move the throttle to the slow position. Allow the engine to return to idle before shutting off.
2. Turn the engine off and remove the key.
3. Remove the collection bag, if used, and follow employer's procedures for the safe handling and disposal of the collected material.
4. Disconnect the hose.



**SECTION VI
MAINTENANCE**

 **DANGER** The internals of this equipment has parts that can crush and cut. Follow Lockout/Tagout information in the "IMPORTANT SAFETY INFORMATION" section before service or maintenance. Failure to do so will lead to serious injury or death if a body part contacts a moving internal part. In addition, the equipment and the parts are heavy, see the "**Heavy – handle safely**" information in the "IMPORTANT SAFETY INFORMATION" section.

ENGINE: The cooling fan screen should be cleared of dust and debris after every use. Refer to the engine manual provided for additional service and maintenance information.

BATTERY: The battery provided with your equipment is of the lead-acid type. The battery cables should be checked daily for corrosion and tightness. Clean and tighten as necessary.

FAN HOUSING AND WHEEL MAINTENANCE: No maintenance is required on the fan wheel or housing. If issues are suspected, contact the factory. Do not attempt to fix or repair any issues.

The fan wheels are designed and manufactured specifically for these vacuums. Replacement fan wheels are only available from Meyer.  **WARNING** Do not attempt to substitute. Doing so may lead to a catastrophic failure of the vacuum and serious injury or death. Contact Meyer at 1-800-963- 4458 for replacement parts and if you have any questions or concerns.



SAFETY SUPPLEMENT

Effective 11-1-2015

ATTENTION INSTALLERS/OPERATORS FOR YOUR PROTECTION:

1. Read and understand the Operating Manual accompanying this equipment before performing any work.
2. Additional safety label kits are available from Meyer upon request at no charge. This is part of our effort to ensure this equipment is installed, operated and maintained in the safest possible manner. Affix these labels in locations to achieve maximum visibility and thereby alert any personnel that may ever be on-site that a potential for injury could occur.
3. Under no circumstances should this equipment be installed or operated in a manner that permits access to the interior of the vacuum.
4. Inlet and Outlet connections must always have collection device or hose attached.
5. In the event that the inlet or outlet is ever exposed, proper guarding to prevent access to the vacuum interior must be installed immediately and prior to start-up.
6. **Always shut off unit and remove key** before performing any work.
7. Always keep loose clothing, hands, feet or any parts of your body, tools and/or any foreign objects away from the inlet and outlet of the vacuum.
8. Never remove any collection device or hose that is on the vacuum without first shutting the vacuum down and removing the key.
9. Consult the Meyer factory if you have any questions regarding the proper installation, operation and maintenance of this equipment.

Wm. W. Meyer & Sons, Inc.

1700 Franklin Blvd • Libertyville, IL 60048 • Phone: 847-918-0111 • Fax: 847-918-8183

Website: <http://www.meyercontractor.com>

File # 291-N-002

PORTABLE VACUUM SAFETY PRECAUTIONS

TYPICAL PORTABLE VACUUM, IMAGES ARE FOR REFERENCE ONLY.



ALWAYS SHUT DOWN VACUUM AND REMOVE IGNITION KEY BEFORE SERVICING OR MAINTAINING.

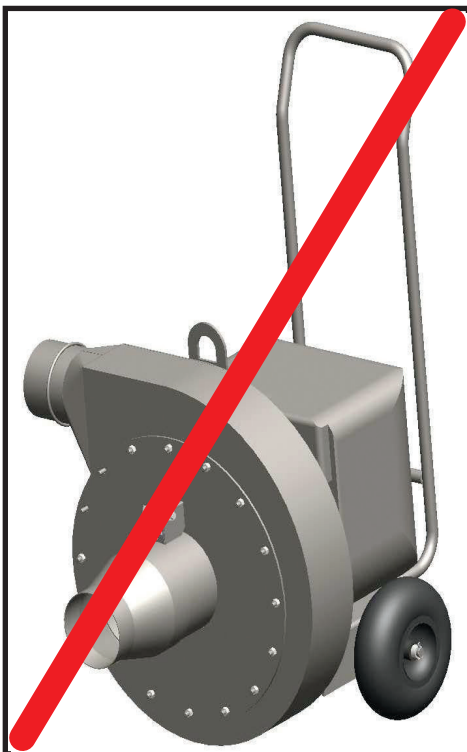

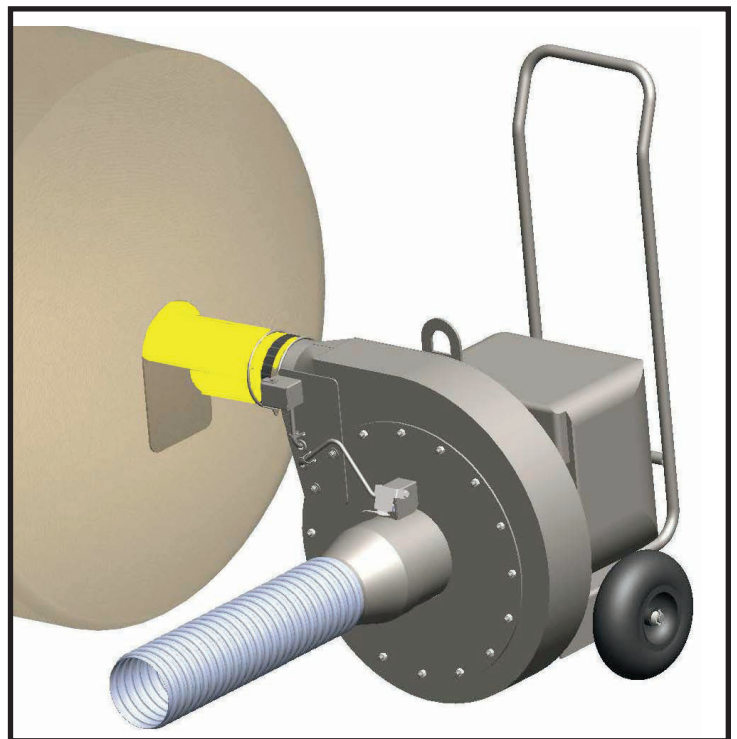

NEVER OPERATE THE VACUUM WITHOUT HOSE ATTACHED TO INLET OR CONNECTION DEVICE ATTACHED TO OUTLET.



SAFETY LABELS

Locate all of the safety labels on your equipment and know their meaning before operating your Portable Vacuum.

	! WARNING	 Scan code for instruction manual
	To reduce the risk of serious injury or death: Equipment must be operated, serviced and maintained by trained personnel. Read and understand all instructions before operating, maintaining or servicing this machine.	

420Z-235

	! WARNING
	Hot surface. Do NOT touch.

420Z-233

	! DANGER
	Turn OFF & remove key from ignition before servicing or maintaining equipment. Rotating fan blades inside can crush or cut. Read and understand all instructions before operating, maintaining or servicing this machine.

420Z-208

	! DANGER
	Engines produce carbon monoxide which is an odorless deadly poison. DO NOT OPERATE in an enclosed area.

420Z-234

	! WARNING
	Stay clear of outlet and surrounding area when operating. Pressurized gas and material leaving outlet can cause severe injury or death if personnel are struck. Rotating fan blades inside can crush or cut. Never operate without collection device securely connected to outlet.

420Z-209

 WARNING
Attach debris guard or hose before starting vacuum. Failure to do so could result in serious injury or death Flying objects leaving discharge.

420Z-265

	! WARNING
	Stay clear of inlet when operating. Strong suction – clothing, hair, body parts, and other objects may be pulled into inlet. Rotating fan blades inside can crush or cut. Avoid wearing loose clothing or jewelry when operating.

420Z-210

 WARNING
Flying objects leaving discharge. Debris guard or hose must be attached to discharge before operating vacuum. Failure to do so could result in serious injury or death.

420Z-263

! WARNING					
 Hearing protection required	 Eye protection required	 Breathing protection required	 Protective clothing required		

420Z-204

 WARNING
This side must face up. Failure to install the debris guard properly could result in serious injury or death. Flying objects leaving discharge.

420Z-267

NOTE: Contact Wm. W. Meyer & Sons, Inc. at 800-963-4458 for free replacement safety label kit.

SAFETY SUPPLEMENT

**Wm. W. Meyer & Sons, Inc.
1700 Franklin Blvd.
Libertyville, IL 60048**

800-963-4458

**www.meyercontractor.com
sales@wmwmeyer.com**